

# Chroma-Q®

## Studio One 100 T™

User Manual



**Chroma-Q®**  
BRILLIANT SOLUTIONS

Version 1.0 September 2015, Software Version 1.6

PN: 638-0706

## Warranty Statement

Chroma-Q warrants to the original purchaser, with proof of purchase, that its delivered products shall be free from defects in material and workmanship under normal use for a period of 12 months from date of shipment.

Chroma-Q will repair, or at its option, provide an equivalent item or replace, the defective product during the stated warranty period. This warranty applies only to the repair or replacement of the product and only when the product is properly handled, installed and maintained according to Chroma-Q instructions. This warranty excludes defects resulting from improper handling, storage, installation, acts of God, fire, vandalism or civil disturbances. Purchaser must notify Chroma-Q in writing within 14 days of noticing the defect. This warranty excludes field labour or service charges related to the repair or replacement of the product.

The warranty contained herein shall not extend to any finished goods or spare parts from which any serial number has been removed or which have been damaged or rendered defective (a) as a result of normal wear and tear, wilful or accidental damage, negligence, misuse or abuse; (b) due to water or moisture, lightning, windstorm, abnormal voltage, harmonic distortion, dust, dirt, corrosion or other external causes; (c) by operation outside the specifications contained in the user documentation; (d) by the use of spare parts not manufactured or sold by Chroma-Q or by the connection or integration of other equipment or software not approved by Chroma-Q unless the Customer provides acceptable proof to Chroma-Q that the defect or damage was not caused by the above; (e) by modification, repair or service by anyone other than Chroma-Q, who has not applied for and been approved by Chroma-Q to do such modification, repair or service unless the Customer provides acceptable proof to Chroma-Q that the defect or damage was not caused by the above; (f) due to procedures, deviating from procedures specified by Chroma-Q or (g) due to failure to store, install, test, commission, maintain, operate or use finished goods and spare parts in a safe and reasonable manner and in accordance with Chroma-Q's instructions (h) by repair or replacement of engines without factory training.

The warranty contained herein shall not apply to finished goods or spare parts which are sold "as is", as "second-hand", as used", as "demo" or under similar qualifications or to Consumables ("Consumables" is defined as any part(s) of goods or part(s) for use with goods, which part(s) of goods or part(s) for use with goods are consumed during the operation of the goods and which part(s) of goods or part(s) for use with goods require replacement from time to time by a user such as, but not limited to, light bulbs).

The warranty contained herein shall not apply, unless the total purchase price for the defective finished goods or spare parts has been paid by the due date for payment.

The warranty contained herein applies only to the original purchaser and are not assignable or transferable to any subsequent purchaser or end-user.

This warranty is subject to the shipment of the goods, within the warranty period, to the Chroma-Q warranty returns department, by the purchaser, at the purchasers' expense. If no fault is found, Chroma-Q will charge the purchaser for the subsequent return of the goods.

Chroma-Q reserves the right to change the warranty period without prior notice and without incurring obligation and expressly disclaims all warranties not stated in this limited warranty.

## Disclaimer

The information contained herein is offered in good faith and is believed to be accurate. However, because conditions and methods of use of our products are beyond our control, this information should not be used in substitution for customer's tests to ensure that Chroma-Q products are safe, effective, and fully satisfactory for the intended end use. Suggestions of use shall not be taken as inducements to infringe any patent. Chroma-Q sole warranty is that the product will meet the sales specifications in effect at the time of shipment. Your exclusive remedy for breach of such warranty is limited to refund of purchase price or replacement of any product shown to be other than as warranted.

Chroma-Q reserves the right to change or make alteration to devices and their functionality without notice due to our ongoing research and development.

The Chroma-Q Studio One 100 range has been designed specifically for the lighting industry. Regular maintenance should be performed to ensure that the products perform well in the entertainment environment.

If you experience any difficulties with any Chroma-Q products please contact your selling dealer. If your selling dealer is unable to help please contact [support@chroma-q.com](mailto:support@chroma-q.com). If the selling dealer is unable to satisfy your servicing needs, please contact the following, for full factory service:

**Outside North America:**

Tel: +44 (0)1494 446000  
Fax: +44 (0)1494 461024  
[support@chroma-q.com](mailto:support@chroma-q.com)

**North America:**

Tel: 416-255-9494  
Fax: 416-255-3514  
[support@chroma-q.com](mailto:support@chroma-q.com)

For further information please visit the Chroma-Q website at [www.chroma-q.com](http://www.chroma-q.com).

Chroma-Q and Studio One 100 T are trademarks, for more information on this visit [www.chroma-q.com/trademarks](http://www.chroma-q.com/trademarks).

The rights and ownership of all trademarks are recognised.

**Important Notice:**

As per the requirements in the Occupational Safety and Health Administration standards for product approval, please refer to the OSHA web pages <http://www.osha.gov/dts/otpc/nrtl/> for information on the list of Nationally Recognized Testing Laboratories (NRTLs) and the scope of recognition.

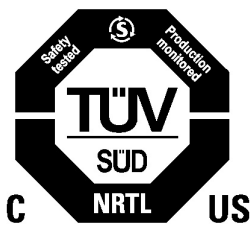

# Table of Contents

<b>1.</b>	<b>Product overview</b> .....	<b>4</b>
<b>2.</b>	<b>Operation</b> .....	<b>5</b>
2.1	Unpacking the Units .....	5
2.2	Cabling .....	5
2.3	Mounting .....	5
2.4	Optics .....	5
2.5	Control .....	6
2.6	DMX Protocol .....	13
2.7	Thermal Performance .....	13
<b>3.</b>	<b>Troubleshooting</b> .....	<b>13</b>
<b>4.</b>	<b>Specification</b> .....	<b>14</b>
4.1	Technical Specifications .....	14
4.2	Drawings – Dimensions .....	15
<b>5.</b>	<b>Maintenance</b> .....	<b>15</b>

## 1. Product overview

The new **Chroma-Q® Studio One 100™** LED Par is designed to deliver the highest quality of white light from an LED based fixture, for the most demanding applications.

Utilising core LED technology from the Chroma-Q premium performance lighting range, the multi-purpose fixture is ideal for a wide range of environments and provides a powerful, creative lighting tool.

The Studio One's custom optical design and fully homogenised output provides a smooth, uniform and defined 18° beam.

Theatrical grade dimming emulates the extremely smooth dimming curve of tungsten fixtures.

The Studio One 100 offers adjustable dimming frequencies to ensure flicker-free operation on cameras.

With the advanced feature set also including convection cooling for silent operation and a versatile mounting yoke, the Studio One 100 is suitable for numerous TV, film, studio, exhibition & entertainment lighting applications - complementing the popular Chroma-Q Studio Force™ and Studio Force Phosphor™ LED fixtures ranges.

With a simple to use Infra-Red remote control included with each fixture, you can be up and running within minutes without the requirement of a lighting console - saving time and labour with instant access to pre-set colour temperatures, on/off, dimming and effects.

To enable maximum flexibility with users' existing production inventory, the Studio One accepts industry-standard 6.25" accessories such as egg crates, barndoors and top hats.



### Note: HANDHELD COLOUR METERS

- Handheld Colour Meters provide a limited measuring range for LED fixtures, which results in inconsistent and unreliable data.
- All photometric values listed in this document are based on testing and measurements conducted by certified independent laboratories with reference to the IES standards.

## 2. Operation

### 2.1 Unpacking the Units

The Studio One 100 T package includes 1 unit fixture, power cord, power connector, colour frame, a Quick Start Guide and an IR Remote.

We recommend that you keep the original packaging in case the item needs to be returned.

### 2.2 Cabling

The Studio One 100 T is built with chassis mount powerCon connectors for power input and through; chassis mount XLR 5-pin connectors for DMX control data input and through.

The enclosure is ground bonded.

XLR 5-pin Cable:

Pin#	Function
1	Ground (Screen)
2	Data Minus
3	Data Plus
4	Spare Data Minus
5	Spare Data Plus

Power Cable:

International Colour Code	North American Colour Code	Connections	
Green and Yellow	Green	Earth (E)	Ground (Green)
Blue	White	Neutral (N)	Neutral (Silver)
Brown	Black	Live (L)	Hot (Gold)

**Important Notice:** The use of an opto-splitter for DMX signal distribution is highly recommended when several fixtures are not plugged into the same power source.

### 2.3 Mounting

The Studio One 100 T is built with a split yoke system for floor mounting and overhead hanging applications.

Secure the fixture with a safety bond when hung. A provision for a fixing hold is built into the fixture.





### 2.4 Optics

The Studio One 100 T is built with an optical lens that provides a fully homogenised beam angle of approximately ~ 18°.

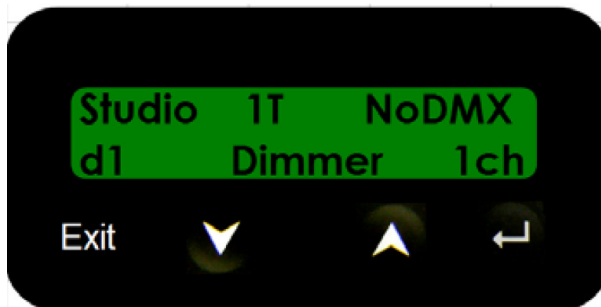
## 2.5 Control

The Studio One 100 T is controlled remotely via ANSI E1.11 USITT DMX512-A protocol or can operate as a standalone unit with the wireless IR Remote. The control functions can be accessed through the LCD display at the rear of the fixture with 4 push buttons.



	Back Arrow	(Enter) Stores the menu choice
	Up Arrow	Increases (+) the mode level or value
	Down Arrow	Decreases (-) the mode level or value
	Exit	Back to the previous menu

### Power-Up Display:

On power-up, the display shows the Brand, Model Name and Software Version for 5 seconds then goes on to show the Main Menu. The Main Menu shows:

- Model Name
- DMX Status
- DMX Address
- Set Control Personality (Mode)
- Number of Assigned Channels

### Display Mode:

The LCD is backlit when you access the menus. This will switch off when left undisturbed for 10 seconds.

### Personality:

The Studio One 100 T features a single Warm White LED engine which is controlled through three Personality modes:

Display	Ch	Description
1-Dimmer	1	1 DMX channel for the control of all LEDs
2-Master		The unit is set as the Master unit. All settings of the Master unit will be repeated on all Slave units.
3-Slave		The unit is set as the Slave unit. All settings of the Slave units follow the Master unit.

### Wireless IR Remote:

The Studio One 100 T can be controlled via wireless IR Remote in standalone operation. The fixture is set in IR Remote control by selecting IR Remote in the menu No DMX Present.

Point the IR Remote towards the fixture.

The IR Remote features buttons for the following control options:

	<ul style="list-style-type: none"> <li>• On and Off</li> <li>• Fade In and Out</li> <li>• White</li> </ul> <p>Color and Effects Buttons applicable to the Color One 100 units:</p> <ul style="list-style-type: none"> <li>• 15 Colors</li> <li>• 4 Effects: Full Color Scroll (Flash), Warm Color Scroll (Strobe), Fade In/Fade Out, and Cold Color Scroll (Smooth)</li> </ul>
---	--



## Control Menu

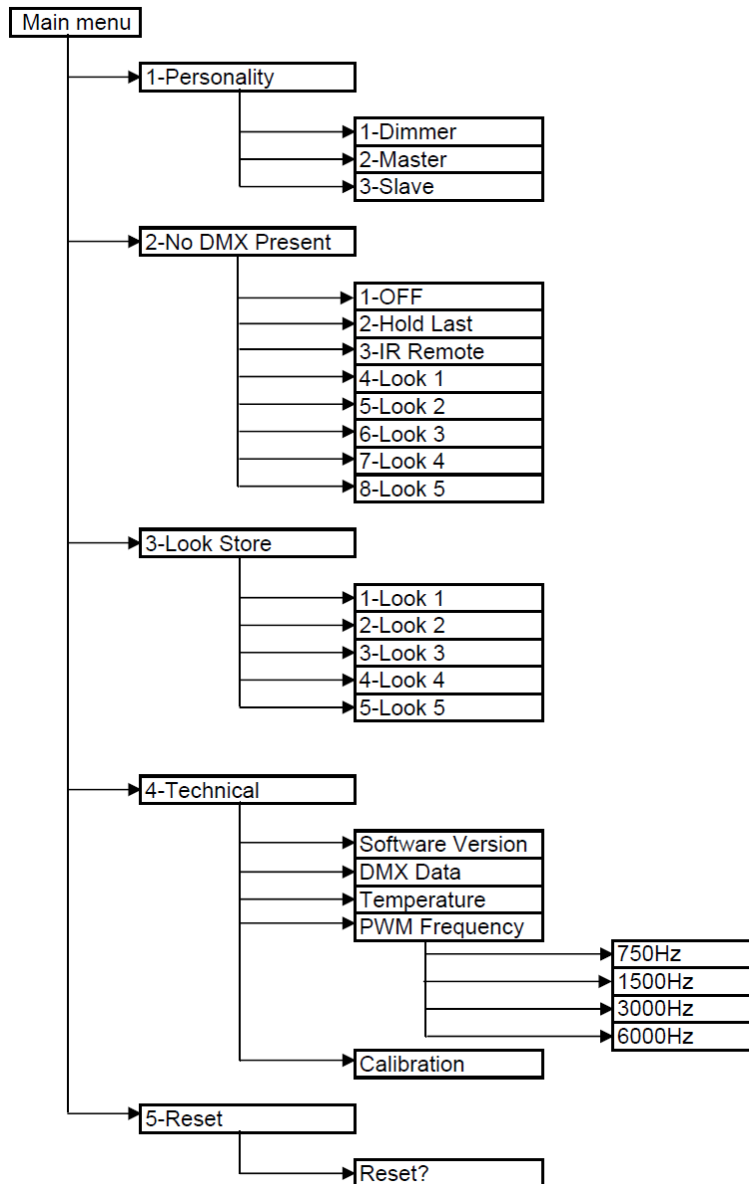

- Use the **Up** and **Down** arrows to navigate the control menu options
- Press **Enter** to select a control menu option
- Press **Enter** to save the setting, display shows Done and returns to the previous menu
- Press **Exit** to return to the previous menu without saving
- The display goes back to the Main Menu

## Main Menu

The Main Menu displays the following:

- Model name
- DMX status
- DMX start address
- Personality (Control Mode)
- Number of assigned channels

- To set the DMX start address,
1. From the Main Menu, press **Enter**.
  2. Press **Up** or **Down** to adjust the DMX start address.
  3. Press **Enter** to save.
- Display shows Done and returns to the Main Menu.

- 1-Personality
- The Studio One 100 T can be set to operate in DMX controlled and standalone modes. Refer to the list below for details.

To set the Personality,

1. From the Main Menu, press **Up** or **Down** to access 1-Personality.
2. Press **Enter** and then **Up** or **Down** to select the mode.
3. Press **Enter** to save.

The display shows Done, returns to 1-Personality and then the Main Menu.

Personality – Software Version 1.6

Display	Ch	Description
1-Dimmer	1	All LEDs
2-Master	0	Set as master unit in standalone
3-Slave	0	Set as slave unit in standalone



## 2-No DMX Present

If DMX control signal from an external source is not detected, various standalone output options can be selected:

1-OFF	Fixture has no light output
2-Hold Last	Fixture holds the last valid DMX state
3-IR Remote	Fixture is controlled via remote infrared control unit
4-Look 1	Fixture snaps to saved Look
5-Look 2	Fixture snaps to saved Look
6-Look 3	Fixture snaps to saved Look
7-Look 4	Fixture snaps to saved Look
8-Look 5	Fixture snaps to saved Look

To set the option when there is No DMX Present,

1. From the Main Menu, press **Up** or **Down** to access 2-No DMX Present.
2. Press **Enter**, then press **Up** or **Down** to select the option.
3. Press **Enter** to save.

The display shows Done, returns to 2-No DMX Present and then the Main Menu.



### 3-Look Store

In this mode,

- 5 internal preset Looks are available for stand-alone operation (see No DMX Present).
- Looks created from an external DMX console can be recorded in any of the 5 Look numbers and will be preserved on power down.
- Looks that have been recorded can be modified in stand-alone operation.
- Looks will be returned to default setting if reset is performed.

To recall a Look in stand-alone operation,

1. From the Main Menu, press **Up** or **Down** to access 3-Look Store.
2. Press **Enter** and press **Up** or **Down** to select from Look 1 to 5.
3. Press **Enter** after the display shows Recall?
4. Press **Up** or **Down** to increase or decrease the intensity "I" from 0 to 100.
5. Press and hold **Enter** to save the Look, the display shows Recorded and the Look turns On.

To record a Look created from a remote DMX console:

1. Set the fixture to the desired Personality.
2. Use an external DMX console to adjust the assigned channel levels and create the desired look or effect.
3. From the Main Menu, press **Up** or **Down** to select 3-Look Store.
4. Press **Enter**, press **Up** or **Down** to select the Look number and the display shows Record?
5. Press **Enter** to record the Look and the display shows Recorded.

To create or modify a Look in stand-alone operation:

1. From the Main Menu, press **Up** or **Down** to select 3-Look Store.
2. Press **Enter**, press **Up** or **Down** to recall the Look number.
3. Press **Enter** and the display shows "I" (Intensity) at the top row and the value below.
4. Press **Up** or **Down** to increase or decrease the Intensity value.
5. Press and hold **Enter** until the display shows Recorded.



#### 4-Technical

In this mode,

- Software Version is displayed.
- DMX Data (value) of the channel is displayed.
- Internal temperature is displayed.
- The fixture can be set to 4 frequency options. The LED scan rate can be synchronised with the video camera to avoid a flickering effect.

Frequency options:

750 Hz	1500 Hz	3000 Hz	6000 Hz
--------	---------	---------	---------

- Calibration data of the channel is displayed.

To display the Software Version,

1. From the Main Menu, press **Up** or **Down** to access 4-Technical.
2. Press **Enter**, the display shows the Software Version.

To display DMX Data,

1. From the Main Menu, press **Up** or **Down** to access 4-Technical.
2. Press **Enter**, **Up** or **Down** and select DMX Data.
3. Press **Enter**, the display shows the DMX channel value.

To display the temperature of the LED Engine in the fixture,

1. From the Main Menu, press **Up** or **Down** to access 4-Technical.
2. Press **Enter**, **Up** or **Down** and select Temperature.
3. Press **Enter**, the display shows the LED Engine Temperature.

To set the Frequency,

1. From the Main Menu, press **Up** or **Down** to access 4-Technical.
2. Press **Enter**, **Up** or **Down** and select PWM Frequency.
3. Press **Enter**, **Up** or **Down** and select a frequency option.
4. Press **Enter** to save.

The display shows Done and returns 4-Technical and then Main Menu.

To display the Calibration data,

1. From the **Main Menu**, press **Up** or **Down** to access 4-Technical.
2. Press **Enter**, **Up** or **Down** and select Calibration.
3. Calibration data of the channel is displayed.

→ 5-Reset

To reset the fixture to the factory default settings,

1. From the Main Menu, press **Up** or **Down** to access 5-Reset.
2. Press **Enter**, display shows reset?
3. Press and hold **Enter** for 2 seconds, display shows Hold for 2 sec. and Done, then back to the Main Menu.

All control menu commands are reset to factory defaults:

DMX address	1
Personality	Dimmer
No DMX Present	Hold Last
Look Store	1
PWM Frequency	750Hz

## 2.6 DMX Protocol

DMX Personality:

<b>Studio One 100 T V1.6</b>	1-Dimmer [1 ch]
Channel 1	All LED
Total	1 DMX channel

## 2.7 Thermal Performance

The internal cooling system of the Studio One fixture is by convection and built with automatic protection. The fixture's automatic protection reduces the output when the internal temperature reaches the maximum limit due to extreme ambient conditions.

## 3. Troubleshooting

Troubleshooting is a process of elimination. First, rule out the other field factors (i.e. bad connections, faulty cables and power supplies). For technical support and/or parts, please contact your selling dealer or the offices listed in this manual.

Symptom	Possible Cause	Solution
Fixture does not respond to DMX control.	Set to wrong or different DMX address. Bad cable connecting DMX control and fixture. Bad in/through connection between adjacent fixtures.	Check DMX address and Mode settings. Check/replace DMX run from the console.
Low LED output.	Internal temperature is over the limit.	Check area ventilation.

## 4. Specification

### 4.1 Technical Specifications

Product Code	CHSONE100T
Net Dimensions** (Without Fixings - Width x Height x Depth)	214mm x 267mm x 232mm / 8.5" x 10.5" x 9" (Full open yoke)
Net Weight (Without Fixings)	3.8 kg / 8.5 lb
Shipping Dimensions – Width x Height x Depth	406mm x 228mm x 292mm / 16" x 9" x 11.5"
Shipping Weight	5.5 kg / 12 lb
Power & Connections	
Power Supply	Built-in
Power Input Rating	100-240V AC 50-60Hz 125VA
Power Factor	0.5
Power Consumption	60W @ 120V AC; 61W @ 230V AC
Inrush Current	15A @ 120V AC; 36A @ 230V AC
Idle Power Consumption	3W @ 120V AC; 5W @ 230V AC
Typical Power & Current	Measurements done with all LEDs at maximum intensity. Measurements made at nominal voltage. Allow for a deviation of +/- 10%.
Power connector In/Out	powerCon
Data Connectors In/Out	XLR 5-pin
Control Protocol	ANSI E1.11 USITT DMX 512-A
Cooling System	Convection
Operating Temperature	0°C to 40°C
Construction	Cast machined aluminium
Colour	Black (custom colours available on request)
Built-In Hardware	Split yoke, 6.25" Accessory Holder
IP Rating	IP20
Approvals	CISPR 15/EN55015& EN61547, FCC Part 15 Subpart B:2012 / ICES-003:2012, CSA C22.2, UL 1573, IEC 60598
Control & Photometric	
LED Engines	1
LEDs Per Engine	Warm White
Control Modes	1 channel Dimmer, Master, Slave
Dimming Curve	Theatrical
Wireless Control	On / Off, Fade In, Fade Out
Hot Lumen Output (Combined)	2,200
Optics	Fully Homogenised
Beam Angle	18° (approx)
Beam Distribution	Symmetrical direct illumination
CCT	3,000K (+/- 200K)
CRI	82
Lamp Life	L70 at 50,000 hours

\*\*For exact measurements please refer to the line drawings below



## 4.2 Drawings – Dimensions

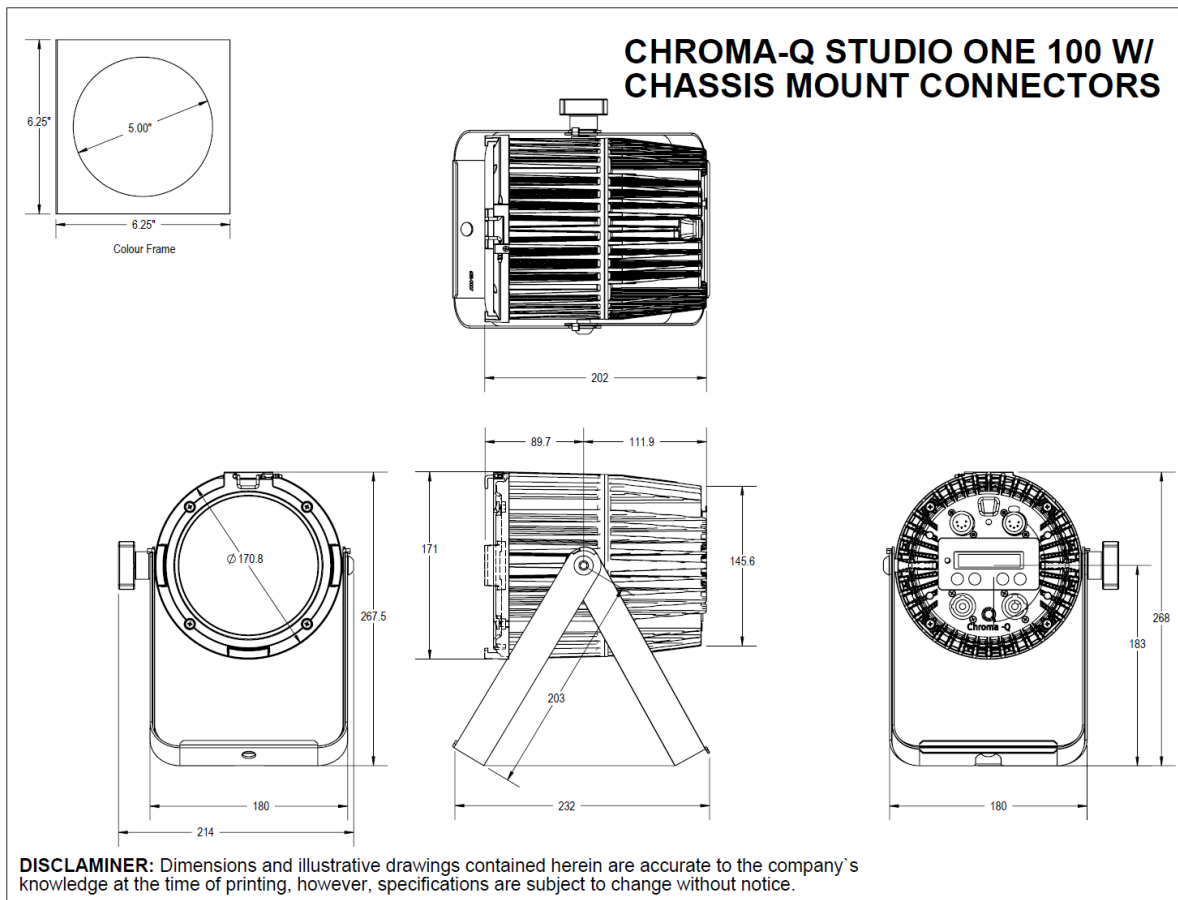

## 5. Maintenance

With care, the Studio One 100 requires little maintenance. However, as the unit is likely to be used in a stage environment we recommend periodical internal inspection and cleaning of any resulting dust and cracked oil residue.

If the front enclosure requires cleaning, wipe with a mild detergent on a damp cloth.